

KINETICS OF THE FORMATION OF WHEWELLITE AND WEDDELITE BY DISPLACEMENT REACTIONS

G. Wiedemann and G. Bayer**

* METTLER INSTRUMENTE AG, CH-8606 GREIFFENSEE, SCHWEIZ

*INSTITUT FÜR KRISTALLOGRAPHIE, ETH ZÜRICH,
CH-8092 ZÜRICH, SCHWEIZ

The nucleation and crystallization of whewellite and weddelite during displacement reactions has been investigated by means of thermomicroscopy, thermogravimetry, X-ray diffraction, and scanning electron microscopy. Gypsum cleavage plates were immersed at different temperatures in solutions of oxalic acid and alkali oxalates. The reaction product (whewellite and/or weddelite) formed on the gypsum crystal surface. Depending on the concentration of the solution and on the time and temperature, different degrees of reaction, which means varying amounts and crystal forms or Ca-oxalate were found. An evaluation of the growth rate was possible by means of thermogravimetry. Conditions for the preparation of pure weddelite by precipitation from solutions have been established.

The formation and stability of Ca-oxalates is of special interest because of their wide-spread occurrence in kidney stones and also in plant cells. According to the literature [1-4] there exist two well-characterized calcium oxalates: the monoclinic monohydrate $\text{Ca}(\text{COO})_2 \cdot \text{H}_2\text{O}$ (Whewellite) and the tetragonal "dihydrate" (Weddelite). The latter is actually a polyhydrate and contains excess zeolitic water in the structural channels. Therefore its formula is written $\text{Ca}(\text{COO})_2 \cdot (2+x) \text{H}_2\text{O}$ with $x=0$ to 1. Figures 1 and 2 show crystal structure projections of the two Co-oxalate hydrates.

It is assumed from experimental evidence that weddelite is the metastable calcium oxalate hydrate. On heating, both whewellite and weddelite decompose to anhydrous Ca-oxalate, which can be rehydrated during or after cooling down, but only to the monohydrate.

Analysis of kidney stones is possible by various chemical and physical methods including X-ray crystallography and IR spectroscopy. Also DTA and TG techniques have been used for this purpose [6, 7]. These thermoanalytical methods are rapid and may give quantitative information about the stone compositions, provided that the thermal behaviour of the individual stone components is known (e.g. oxalate, urate, phosphate, cystine). Also in pure oxalate calculi the proportions

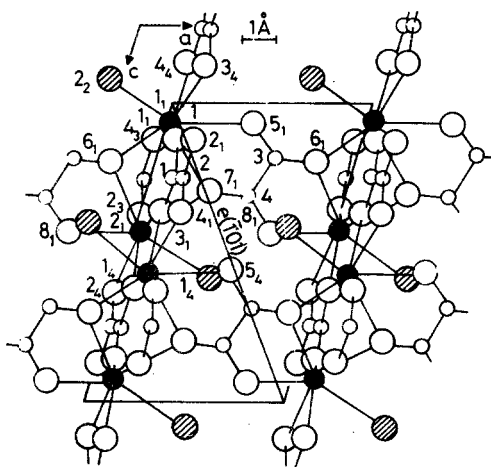

Fig. 1 Structure projection of whewellite [1].

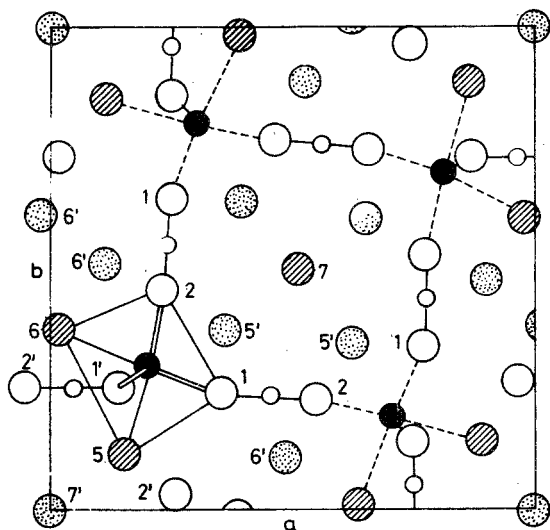

Fig. 2 Structure projection of weddellite [3].

of mono- and polyhydrate can be determined by TG. Such studies confirm, that the centers of Ca-oxalate calculi are richer in polyhydrate than the exterior surface [7].

Many thermoanalytical investigations have also been reported on synthetic calcium oxalate hydrates (e.g. [8–10]). However, such studies were carried out mainly with the monohydrate, which is one of the standard reference materials in

TG and DTA. Compared to the polyhydrate, the monohydrate precipitates easily when calcium and oxalate solutions are brought together, preferably at higher temperatures. At lower temperatures, and in dilute solutions, the polyhydrate may coprecipitate with the monohydrate. Pure weddelite is somewhat difficult to prepare and therefore has not been investigated by thermoanalytical methods as extensively as whewellite [11].

The aim of this present investigation was to determine the conditions for the formation of the mono- and polyhydrate and to investigate their decomposition kinetics by means of TG and X-ray methods. In these studies displacement reactions between gypsum cleavage plates and oxalate solutions have also been conducted. Previous experiments have shown that it is possible to form the reaction products—either insoluble Ca-salts or insoluble sulfates—in situ on and within the gypsum crystal plates [12].

Experimental

Preparation of the calcium oxalate hydrates

Analytical grade chemicals (Merck) were used for the dilute solutions: 0.1 and 0.02 molar $\text{CaCl}_2 \cdot 2\text{H}_2\text{O}$, $(\text{COOH})_2 \cdot 2\text{H}_2\text{O}$, $(\text{COONa})_2$ and $(\text{COOK})_2 \cdot \text{H}_2\text{O}$. Whewellite was prepared by precipitation of any of the oxalate solutions with Calcium chloride at room temperature. Pure weddelite was more difficult to prepare. Coprecipitation of whewellite could be avoided when a Na-oxalate solution was added dropwise to the CaCl_2 -solution under rigorous stirring at 5–15°. The purity of the oxalate precipitates was checked by X-ray powder photographs. For the displacement reaction studies, rhombohedral-shaped gypsum cleavage plates of about 0.5 mm thickness were immersed into the oxalate solutions. Plates of 5 mm edge length with small deviations were used, having approximately identical surface area and weight.

Instrumental techniques

Microscopic investigations were carried out using a polarizing microscope and cameras for still or motion pictures. The gypsum cleavage plates were placed on microscope slides with a round cavity in the center and the salt solutions were introduced below the plates (Fig. 3). Thereby it was possible to follow the displacement reaction on one crystal face only (which was essential for reasons of light transmission and focussing). For a quantitative evaluation of the reaction kinetics, TG- and DTG-curves were recorded and numerically evaluated using the Mettler TA 3000 system. The reaction products were identified by means of a

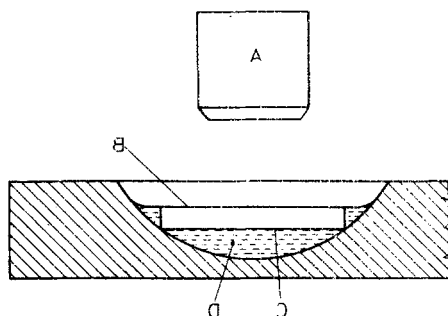

Fig. 3 Slide with sample arrangement for thermomicroscopic measurements. A: microscopic observation, B: gypsum crystal, C: reacting surface, D: solution of oxalic acid

Nonius X-ray camera, System Guinier, with CuK_α -radiation. The thermal decomposition of weddellite and whewellite was also investigated by means of an ENRAF-Nonius high temperature X-ray camera (System, Lenné, CuK_α -radiation). The morphology of the Ca-oxalate crystals could be established from SEM-microphotographs (JEOL, JSM-840).

Results and discussion

Microscopic studies

All the precipitated Ca-oxalates were rather finely grained and rarely showed idiomorphic, well developed crystals in the electron microscope. Alternatively, rather rapid nucleation and crystal growth was observed when gypsum cleavage plates were immersed in oxalic acid or alkali oxalate solutions. The effect of time, temperature and concentration on the formation of Ca-oxalate hydrates is very pronounced. From preliminary experiments it was established that the formation of the oxalates by these types of displacement reactions is as follows: whewellite is formed preferentially with oxalic acid at temperatures slightly above room temperature, whereas weddellite crystallizes mainly in dilute (1%) Na-oxalate solutions at lower temperature, Figs 4 and 5 show SEM pictures of whewellite respectively, which were taken after reaction times in the order of 1/2 to 1 hour. The morphology of the crystals is in fair agreement with the crystal forms described in the literature [1, 13].

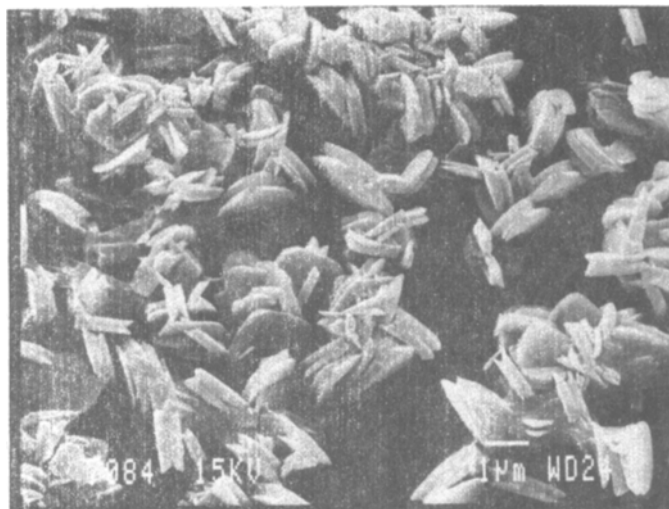

Fig. 4 Formation of whewellite (Ca-oxalate monohydrate) on a gypsum cleavage plate after immersion in an oxalic acid solution (1%), (SEM photograph, 2000 ×)

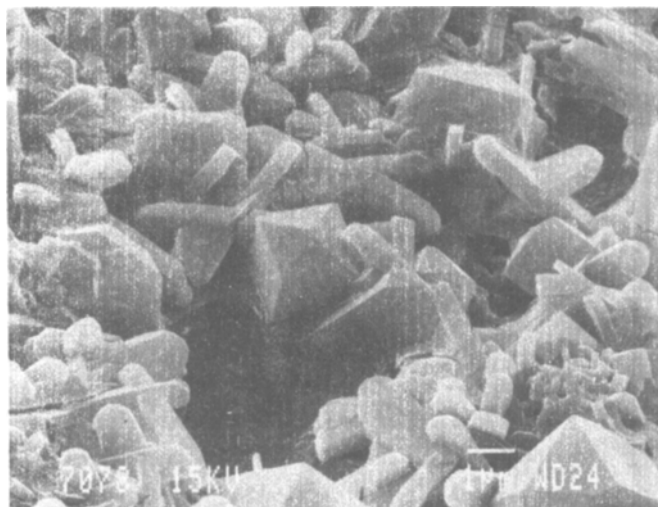

Fig. 5 Formation of weddelite (Ca-oxalate dihydrate) on a gypsum cleavage plate after immersion in a sodium oxalate solution (1%), (SEM photograph, 4675 ×).

Thermogravimetric investigations

Samples of pure whewellite and weddelite, which had been precipitated from solutions, were used in these studies. Figures 6a and 6b show the TG and DTG curves of these two oxalates from 10 to 850°. The dehydration of whewellite to anhydrous Ca-oxalate takes place at 115–170° (heating rate 4 deg min⁻¹). The decomposition of the Ca-oxalate to CaCO₃ follows at 380–485°. Finally CaCO₃ decomposes to calcium oxide at 560–760°.

Weddelite is characterized by the continuous loss of the zeolitic water up to 100°. The dihydrate water is given off in the range between 100 to 260° much slower than in whewellite. The decomposition of the Ca-oxalate to CaCO₃ starts at 360° and is finished by 465°. Calcium carbonate breaks down to CaO in the same temperature range as in the case of whewellite.

These experiments show that weddelite dehydrates in one step, and that no intermediate monohydrate is formed. This was confirmed also by X-ray heating photographs. Another observation was that freshly precipitated weddelite contained more zeolitic water and less than the stoichiometric amount of dihydrate water. After storing for one month in humid atmosphere the zeolitic water had decreased substantially and the dihydrate increased (Fig. 7). This may be due to a rearrangement of the water molecules in the structure of weddelite, or to enhanced crystallization of weddelite by action of the mobile zeolitic water.

For determination of the growth rates of the oxalate mono and dihydrate, gypsum plates were immersed either in oxalic acid or in Na-oxalate solutions for different times and different temperatures. Afterwards, the excess solution was cleaned from the gypsum plates which were then air-dried. These cleavage plates with the oxalate reaction layers were used for TG analysis. From the TG oxalate steps the amount of oxalate formed after different times could be calculated. Some of these curves and the reaction rate derived from them are shown in Fig. 8. The reaction products—whewellite or/and weddelite—were determined by x-ray diffraction analysis.

Calcium oxalate monohydrate has been previously studied also with respect to its dehydration and rehydration in dry air and in water vapor atmosphere [14]. Dehydration in water vapor occurs at slightly higher temperatures. An interesting result was the rapid in situ rehydration of the dry oxalate back to its original crystal hydrate form. Reactions have also been carried out with deuterium oxide to demonstrate possibilities of selective deuteration. Figure 9 shows the dehydration-rehydration of both calcium oxalate monohydrate and calcium monodeuterate in water vapor and deuterium oxide vapor, respectively. Vapor concentration was approximately 95 percent in both atmospheres, complete rehydration takes place in approximately 25 min. The rate of rehydration decreases rapidly with decreasing water vapor pressure.

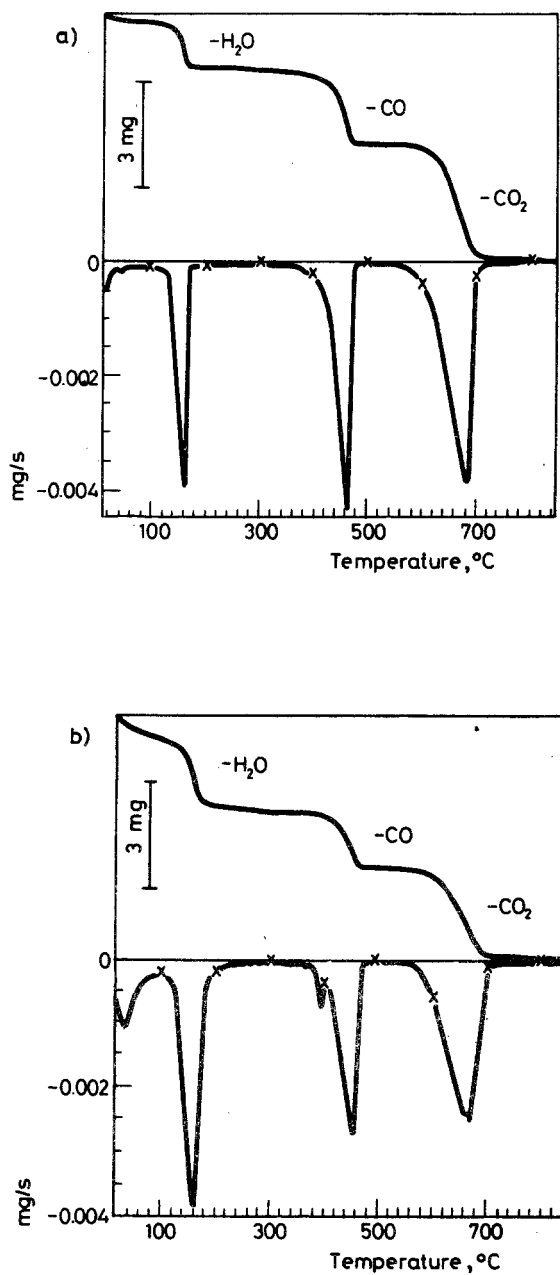

Fig. 6 TG and DTG curves of the decomposition of a) Ca-oxalate monohydrate and b) Ca-oxalate dihydrate. Heating rate: 10 deg/min, atmosphere: air, sample mass: a) 10.035 mg, b) 9.998 mg

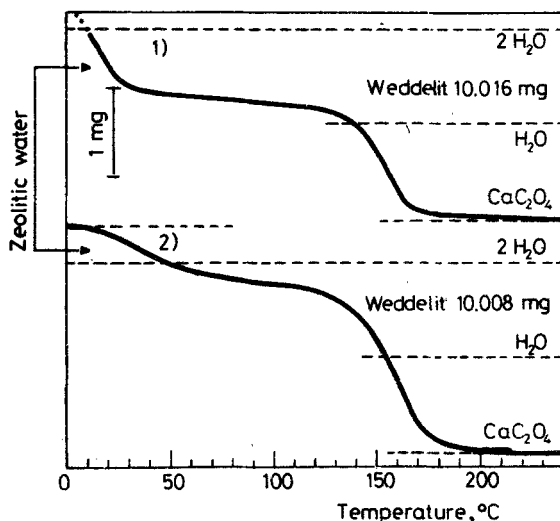

Fig. 7 Dehydration curves of weddelite, immediately after precipitation (1) and after storing for one month in humid atmosphere (2). Heating rate: 4 deg/min

X-ray studies

The thermal stability and decomposition of whewellite and weddelite was investigated also by X-ray heating methods. Figure 10 shows the corresponding photographs. The samples were mounted on a platinum mesh and heated up to 750° with 0.5 deg min⁻¹ in air. Under these conditions whewellite shows the formation of an intermediate phase between 90–150° which will be investigated further. The anhydrous Ca-oxalate decomposes above 350° to CaCO₃ followed by CaO above 540°. These results can be correlated with TG data, taking into account the different heating rates. Weddelite, however, on the other hand showed no formation of an intermediate phase, but is decomposed at 100° directly to the anhydrous Ca-oxalate. From the sharpness of the reflections, one can assume that the oxalate is better crystallized if obtained by the decomposition of the monohydrate.

Conclusions

Conditions for the preparation of pure whewellite and weddelite have been investigated using precipitation and displacement reactions. The monohydrate precipitates more easily from calcium salt solutions with oxalic acid or alkaline oxalates, whereas the formation of weddelite is favored in dilute solutions at lower

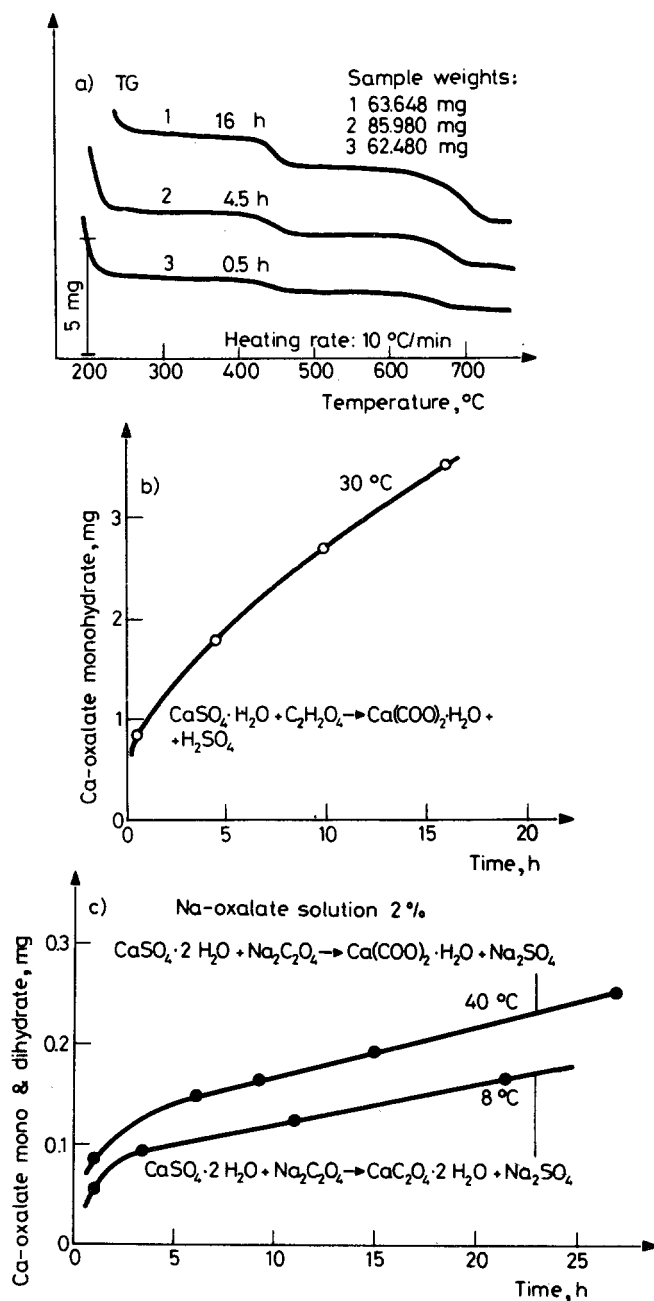

Fig 8 TG-curves of gypsum cleavage plates after immersion in % oxalic acid for different times (a), the growth rate of Ca-oxalate monohydrate is derived from these runs (in 2% oxalic acid) (b), much smaller growth rates of both Ca-oxalate hydrates were found in Na-oxalate solution (2%) at different temperatures (c)

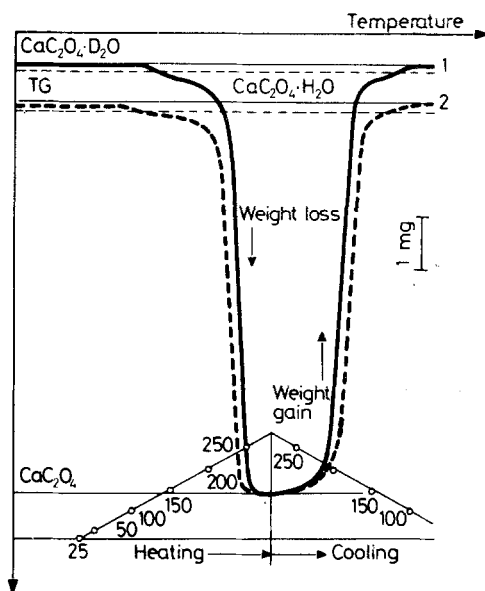

Fig. 9 Dehydration and rehydration of Ca-oxalate monohydrate in water vapor (1) and deuterium oxide (2) atmosphere (5 l/h). Heating rate: 6 deg/min, sample mass: 60.02 mg

temperatures (5 to 15°). This is also true for displacement reactions, where gypsum cleavage plates are immersed with diluted oxalate solutions. In this case, well-crystallized, idiomorphic Ca-oxalates are formed showing the typical growth forms of whewellite and weddelite. Thermoanalytical (TG) and X-ray studies proved that the monohydrate is the stable oxalate form, whereas the dihydrate always contained excess, zeolitic water.

Both hydrates decompose above 110° to anhydrous Ca-oxalate, whereby an intermediate phase was observed in the case of whewellite. The dehydration of weddelite extends over a much wider range, and leads to a poorly crystallized Ca-oxalate. The effect of time, temperature and heating rate on the thermal stability of the Ca-oxalate hydrates was demonstrated by TG- and X-ray heating runs. These parameters, including also the concentration of the solutions are of special importance for the growth rate of the Ca-oxalate hydrates.

* * *

We are grateful to Mr. R. Wessicken, Laboratorium für Festkörperphysik, ETH Zürich, Zürich-Hönggerberg, for taking the SEM-Photographs. Also, the kind help of Dr. A. Reller, Institute of Inorganic Chemistry, University of Zürich, for running the X-ray heating photographs is acknowledged.

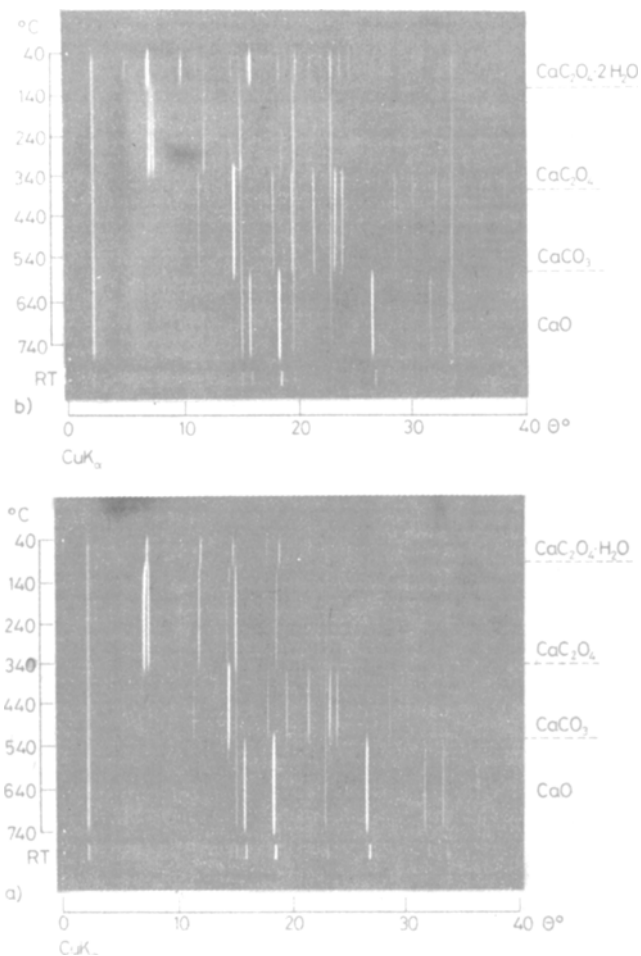

Fig. 10 X-ray heating photographs of Ca-oxalate monohydrate (whewellite) (a) and Ca-oxalate dihydrate (weddelite) (b). Heating rate: 0.56 deg/min

References

- 1 A. Frey-Wissling, *Amer. J. Bot.*, 68 (1) (1981) 130-141.
- 2 H. J. Arnott, F. G. E. Pautard and H. Steinfink, *Nature*, 28 (1965) 1197-1198.
- 3 g. Cocci, *Atti Acad. Naz. Lincei Cl. Sci. Fis. Mat. Nat.*, 31 (1961/62) 292-298.
- 4 C. Sterling, *Acta Cryst.*, 18 (1965) 917-921.
- 5 G. Schubert, G. Brien und C. Bick, VI. Jenaer Harnsteinsymposium 1980, 14-24. Veröffentlichung der Friedr. Schiller Universität, Jena, 1980.

- 6 R. T. Marano, J. L. McAtee et al. *Thermochim. Acta* 4 (1972) 405–409.
- 7 G. A. Rose and C. Woodfine, *Brit. Jour. of Urology*, 48 (1976) 403–412.
- 8 Mettler Thermal Techniques Series, Technical Bulletin T-104 (1968).
- 9 D. Dollimore, T. E. Jones and P. Spooner, *J. Chem. Soc., A* (1970) 2809.
- 10 Y. Masuda, Y. Ito, R. Ito and K. Iwata, *Thermochim. Acta*, 99 (1986) 205–215.
- 11 H.-J. Schneider, W. Götz und K. Heide, *Der Harnstein*, S. 87–181 (1973), VEB Gustav Fischer-Verlag, Jena, 1973.
- 12 G. Bayer and H. G. Wiedemann, *Thermochim. Acta*, 114 (1987) 75–82.
- 13 W. Vahlensieck, *Urolithiasis 1*, Springer-Verlag Berlin, Heidelberg New York, 1979.
- 14 H. G. Wiedemann und A. van Tets, *Die Naturwissenschaften*, 54 (1967) 442.

Zusammenfassung — Keimbildung und Kristallisation von Whewellit und Weddelit bei Verdrängungsreaktionen wurden durch Thermomikroskopie, Thermogravimetrie, Röntgenbeugung und Rasterelektronenmikroskopie untersucht. Gipspaltplättchen wurden bei verschiedenen Temperaturen in Oxalsäure- und Natriumoxalatlösungen eingetaucht. Das Reaktionsprodukt (Whewellit oder Weddelit) bildete sich auf der Oberfläche des Gipskristalls. In Abhängigkeit von der Konzentration der Lösung, der Zeit und der Temperatur wurden verschiedene Umsetzungen, d. h. verschiedene Menge und Kristallformen von Calciumoxalat gefunden. Die Wachstumsgeschwindigkeit ließ sich aus thermogravimetrischen Messungen ermitteln. Die Bedingungen zur Herstellung reinen Weddelits durch Fällung aus der Lösung wurden ermittelt.

Резюме — Методами термогравиметрии, термомикроскопии, рентгенофазового анализа и сканирующей электронной микроскопии изучено образование центров кристаллизации и кристаллизация вевеллита и ведделита в процессе реакций смещения. Расщепленные пластинки гипса были погружены при различных температурах в растворы щавелевой кислоты и ее щелочных солей. Продукты реакции (вевеллит или ведделит) образовывались на кристаллической поверхности гипса. В зависимости от концентрации раствора, времени погружения и температуры раствора, установлены различные степени реакции, означающие различные количества и кристаллические формы образующегося оксалата кальция. Термогравиметрически проведена оценка скорости реакции роста кристаллов. Определены условия получения чистого ведделита путем осаждения из растворов.